



Rd-01 Specification

Version V1.1.0

Copyright ©2023

Content

1. Product Overview	4
1.1. Characteristic	5
2. Main parameters	7
2.1. Static electricity requirements	7
2.2. Electrical characteristics	8
2.3. Radar sensing range	8
2.4. Wi-Fi RF performance	8
2.5. BLE RF performance	9
2.6. Power	9
3. Appearance size	10
4. Pin definition	11
5. Schematic diagram	12
6. Design guidance	13
6.1. Application guide circuit	13
6.2. Recommended PCB package size	13
6.3. Precautions for radar installation	14
6.4. Installation environment requirements	14
6.5. Installation mode and induction range	15
6.6. Power Supply	17
6.7. GPIO	17
7. Storage conditions	18
8. Reflow welding curve diagram	18
9. Product package information	19
10. Contact us	19
Disclaimer and copyright notice	20
Notice	20
Statement	21

1. Product Overview

Rd-01 is a radar module developed by Shenzhen Anxinke Technology Co., LTD. The module supports Wi-Fi&BLE.

Radar part is equipped with the S3KM111L chip of Sidian Micro. S3KM111L is an integrated monolithic single-wave sensor SoC based on FMCW radar technology. Operates in 24 GHz k band with up to 1 GHz modulation bandwidth per frequency. FMCW continuous wave is used to detect the target in the set space. Combined with radar signal processing and accurate human body sensing algorithm, high sensitivity human presence state sensing can be realized to recognize human body in motion and static state.

Wi-Fi&BLE is equipped with BL602 chip as the core processor and supports Wi-Fi 802.11b/g/n and BLE 5.0. The BL602 chip has a built-in low-power 32-bit RISC CPU, 276KB of RAM and a wealth of peripheral interfaces, including SPI, UART, I2C, PWM, ADC and GPIO.

Rd-01 module can sense whether there is a moving or twitching human body in the area, and transmit the detection result in real time through Wi-Fi&BLE. Provide visual configuration tools, it can be easily configured with induction distance range, induction sensitivity of different sections and unmanned delay time. It also supports Wi-Fi&BLE wireless configuration of radar parameters, greatly improving the efficiency of construction and operation and maintenance, convenient and fast.

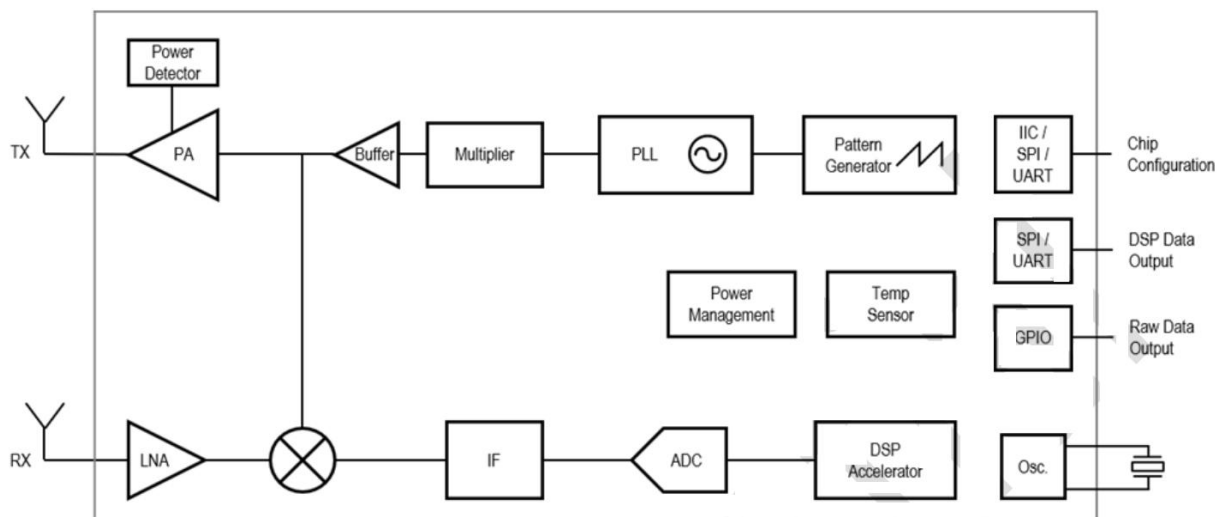

Figure 1 S3KM111L

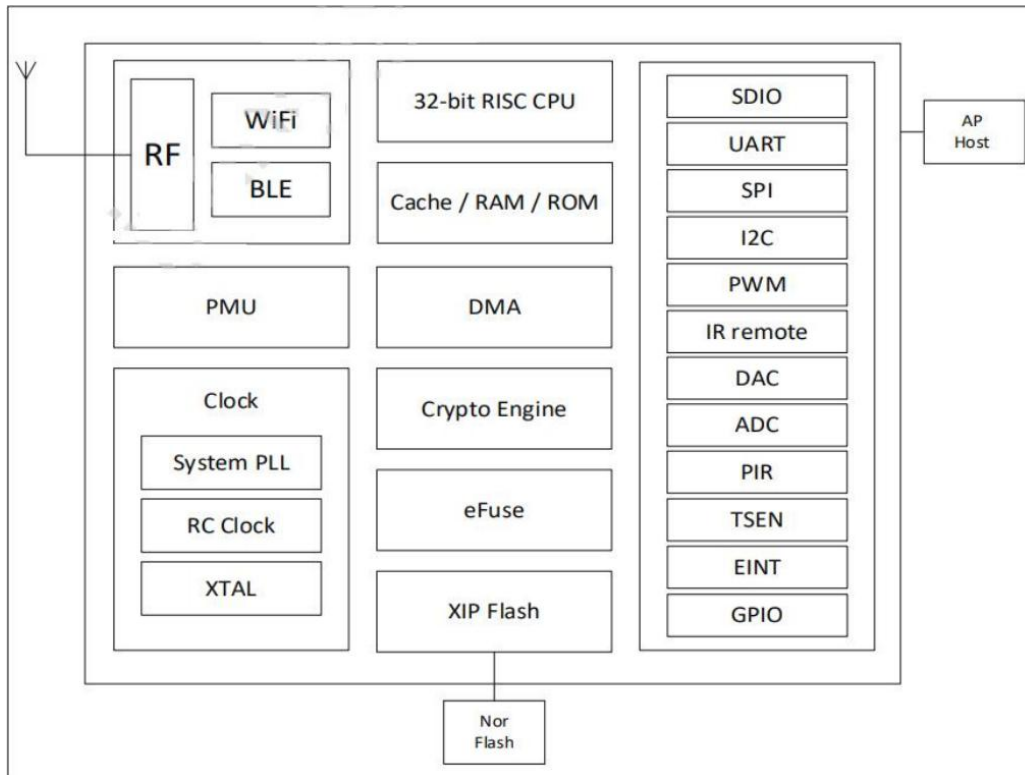

Figure 2 BL602 chip architecture diagram

1.1. Characteristic

- SMD-12 package, compatible with standard socket or pin interface
- Radar support 24 GHZ ISM frequency band
- The radar's max sensing range is up to 5 meters
- Radar Angle is big, range of ± 60 degrees
- Radar range and accurate recognition, support induction range, shielding range outside interference
- It can realize the intelligent parameter adjustment of radar through Bluetooth, convenient and fast
- Support roof, hang a wall to install a variety of ways
- Supports IEEE 802.11 b/g/n agreement
- Wi-Fi security support WPS/WEP/WPA/WPA2 Personal/WPA2 Enterprise/WPA3
- Support 20 MHZ bandwidth, the highest rate of 72.2 Mbps

- Bluetooth low energy 5.0, Bluetooth Mesh
- Support Station + BLE model、 Station + SoftAP + BLE model
- Support 32-bit RISC CPU, 276KB RAM
- Secure startup, supports the use of ECC - 256 signature image
- Support QSPI/SPI Flash instant AES decryption (OTFAD), support AES 128 CTR mode
- Support AES 128/192/ - bit encryption engine
- Support SHA-1/224/256
- Support for real random number generators (TRNG)
- Public key Accelerator (PKA), support the basic operation of large numbers, software provides the signature, authentication and so on application program interface
- Support SPI, UART, I2C, PWM, ADC and GPIO etc.
- Integration Wi-Fi MAC/BB/RF/PA/LNA/BT
- Supports a variety of sleep mode
- Supports secondary development, integrated with Windows, Linux development environment
- Assembly way flexible, compatible patch/needle/socket and so on a variety of ways
- Typical application scenario
- ✓ Human body induction lamp control
- ✓ Advertising screen devices such as the human body induction
- ✓ Life safety protection
- ✓ Smart Application
- ✓ Intelligent security

2. Main parameters

Table 1 main parameters

Model	Rd-01
Package	SMD-12, Compatible with patch/pin/socket and other assembly methods
Size	35.0*18.0*3.6(±0.2)mm
Antenna	Radar: on-board antenna Wi-Fi&BLE: IPEX
Frequency	Radar: 24G ~24.25GHz Wi-Fi: 2400 ~ 2483.5MHz
Operation temperature	-40°C ~ 85°C
Storage environment	-40°C ~ 125°C, < 90%RH
Power supply	Support voltage 3.0V ~ 3.6V, power supply current $\geq 500\text{mA}$
Interfaces	UART/GPIO/ADC/PWM/I2C/SPI
I/O	8
UART rate	Default 115200 bps
Security	WPS/WEP/WPA/WPA2 Personal/WPA2 Enterprise/WPA3
Flash	Default 2MByte

2.1. Static electricity requirements

Rd-01 is an electrostatic sensitive equipment, special precautions should be taken during handling.



Figure 3 ESD anti-static diagram

2.2. Electrical characteristics

Table 2 Electrical Characteristics Table

Parameter	Conditio	Min.	Typical value	Max.	Unit
Power supply	VDD	3.0	3.3	3.6	V
I/O	VIL	-	-	0.3*VDDIO	V
	VIH	-	0.7*VDDIO	-	V
	VOL	-	-	0.1*VDDIO	V
	VOH	-	-	0.9*VDDIO	V
	IMAX	-	-	-	15

2.3. Radar sensing range

Table 3 Radar induced range

Installation	Min.	Typical	Max.	Unit
Wall hanging mode ($\pm 60^\circ$)	-	5	-	M
Roof hanging mode	-	3.5	-	M

2.4. Wi-Fi RF performance

Table 4 Wi-Fi RF performance table

Description	Typical value			Unit
Spectrum Range	2400 ~ 2483.5MHz			MHz
Output power				
Model	Min.	Typical	Max.	Unit
11n mode HT20, PA output power	-	16	-	dBm
11g mode, PA output power	-	17	-	dBm
11b mode, PA output power	-	19	-	dBm
Receiving sensitivity				
Model	Min.	Typical	Max.	Unit
11b, 1 Mbps	-	-98	-	dBm
11b, 11 Mbps	-	-90	-	dBm

11g, 6 Mbps	-	-93	-	dBm
11g, 54 Mbps	-	-76	-	dBm
11n, HT20 (MCS7)	-	-73	-	dBm

2.5. BLE RF performance

Table 5 BLE RF performance table

Description	Typical value			Unit
Spectrum Range	2400 ~ 2483.5MHz			MHz
Output power				
Rate Mode	Min.	Typical value	Max.	Unit
1Mbps	-	9	15	dBm
Receiving sensitivity				
Rate Mode	Min.	Typical value	Max.	Unit
1Mbps sensitivity @30.8%PER	-	-96	-	dBm

2.6. Power

The following power consumption data is based on a 3.3V power supply and an ambient temperature of 25° C

- Test conditions, all transmission power are completed in the antenna interface
- All emission data is based on 100% of the duty ratio, measured in continuous emission mode

Table 6 Power Consumption Table

Model	Min.	AVG	Max.	Unit
Tx 802.11b, 11Mbps, POUT = +21dBm	-	260	-	mA
Tx 802.11g, 54Mbps, POUT = +18dBm	-	245	-	mA
Tx 802.11n, MCS7, POUT = +17dBm	-	230	-	mA
Rx 802.11b, 1024 bytes long	-	65	-	mA
Rx 802.11g, 1024 bytes long	-	65	-	mA
Rx 802.11n, 1024 bytes long	-	65	-	mA

3. Appearance size

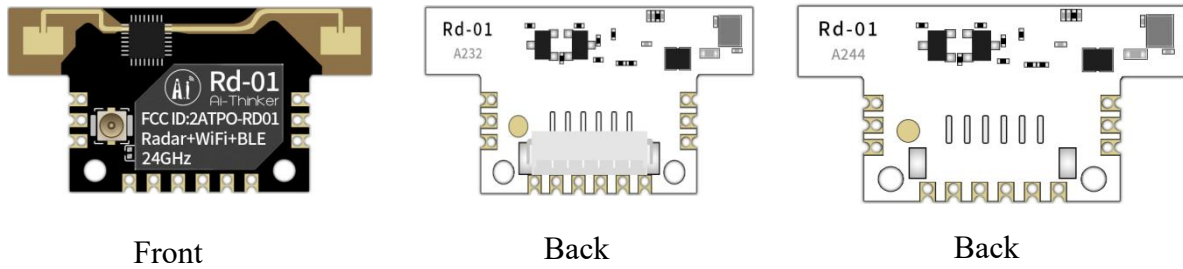

Figure 4 Appearance diagram (rendering diagram is for reference only, subject to the actual object)

Note: Rd-01 module is available with and without sockets.

- The module with socket can be connected to the motherboard with a row of cables, and the installation position is flexible. Socket using standard 1 * 6 p - 1.25 mm distance between interface, at the same time module of positioning hole can be used for screw fixation.
- Modules without sockets can be SMT to the motherboard, easy to improve assembly efficiency.

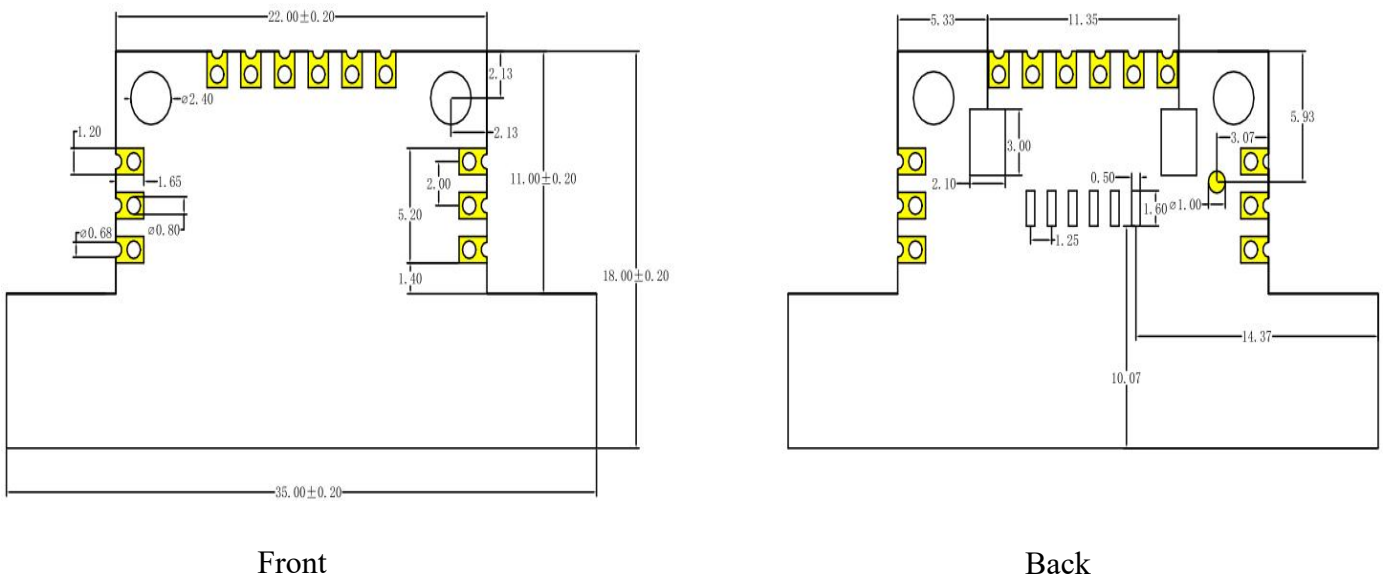

Figure 5 Size chart

4. Pin definition

Rd-01 connects to a total of 12 interfaces, for example, the pin diagram, the pin function definition table is the interface definition.

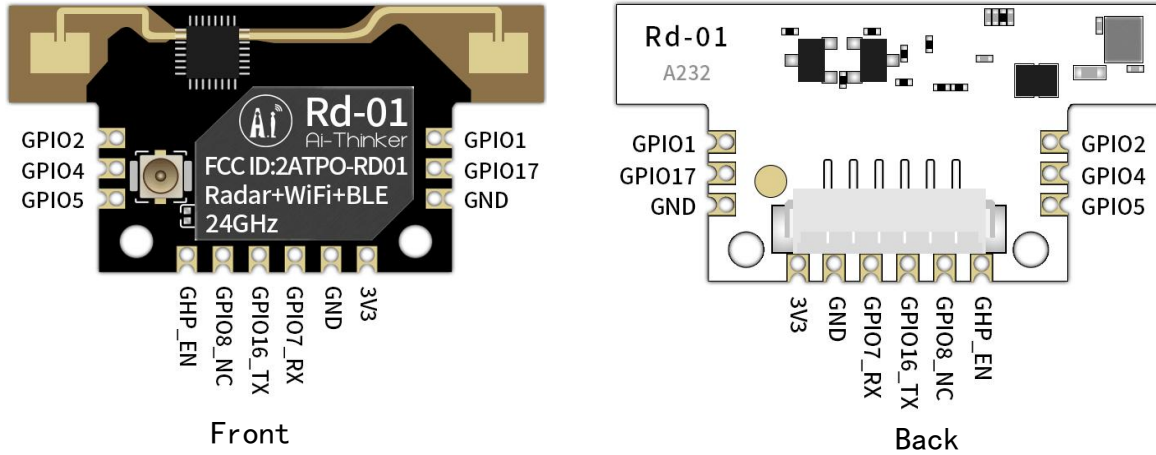

Figure 6 Pin diagram

Table 7 Definition table of pin functions

No.	Name	Function
1,11	GND	Ground
2	GPIO17	GPIO17/SPI_MOSI/MISO/IIC_SDA/PWM_CH2/JTAG_TCK/TMS
3	GPIO1	GPIO1/SPI_MOSI/MISO/IIC_SDA/PWM_CH1
4	GPIO2	GPIO2/SPI_SS/IIC_SCL/PWM_CH2
5	GPIO4	GPIO4/SPI_MOSI/MISO/IIC_SCL/PWM_CH4/ADC_CH1
6	GPIO5	GPIO5/SPI_MOSI/MISO/IIC_SDA/PWM_CH0/ADC_CH4/JTAG_TMS/TCK
7	CHIP_EN	By default, it is enabled on the chip. The high level is valid
8	GPIO8	Bootstrap/GPIO8/SPI_MOSI/MISO/IIC_SCL/PWM_CH3
9	GPIO16	TXD/GPIO16/SPI_MOSI/MISO/IIC_SCL/PWM_CH1/JTAG_TMS/TCK
10	GPIO7	RXD/GPIO7/SPI_SCLK/IIC_SDA/PWM_CH2/JTAG_TDO/TDI
12	3V3	3.3V power supply; It is recommended that the output current of the external power supply be at least 500mA

Note: 1. GPIO8 is used as Bootstrap. The instant of power-on is high power level, and the module enters the burning mode; The power-on moment is at low power level, and the module starts normally.

5. Schematic diagram

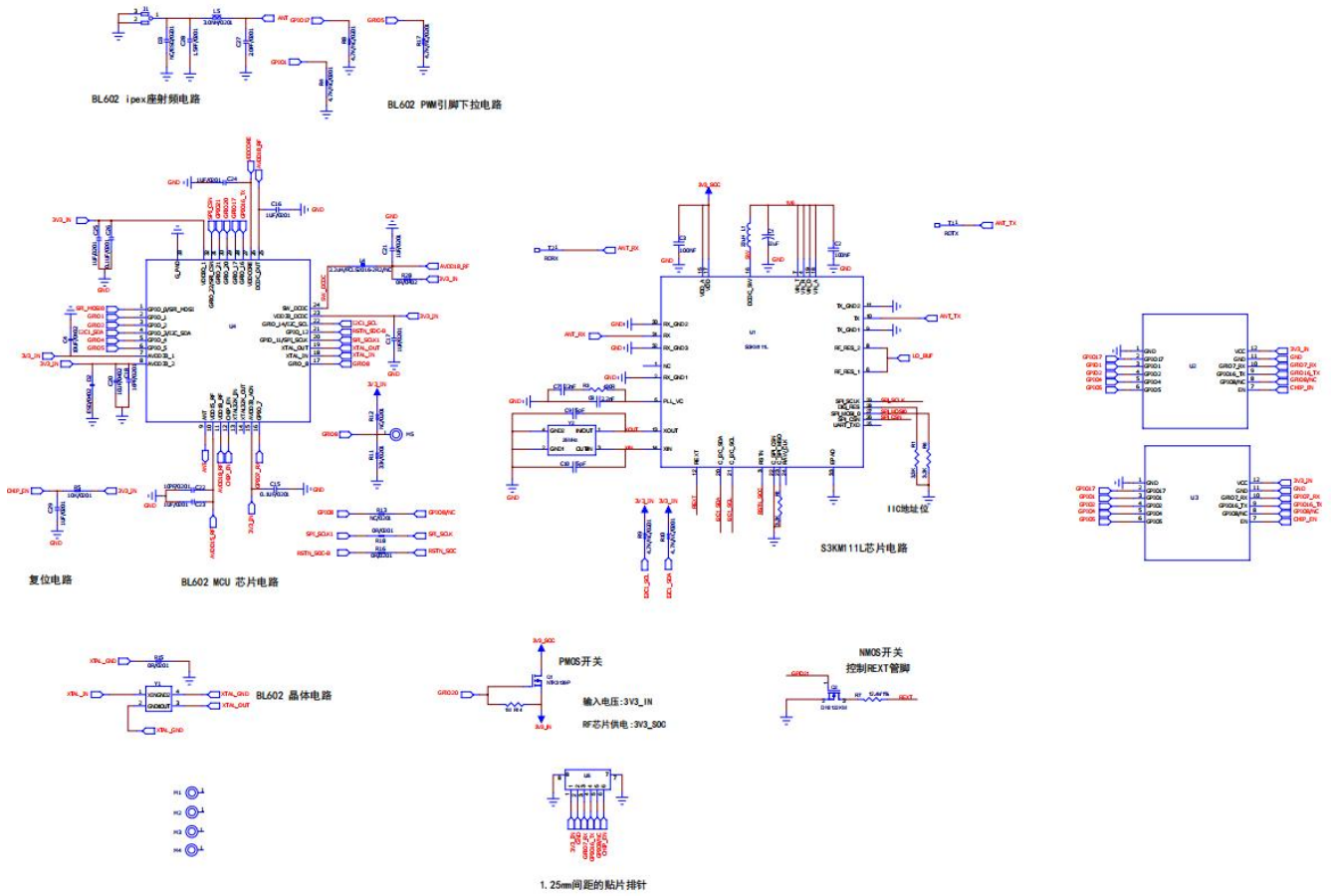

Figure 7 Schematic diagram

6. Design guidance

6.1. Application guide circuit

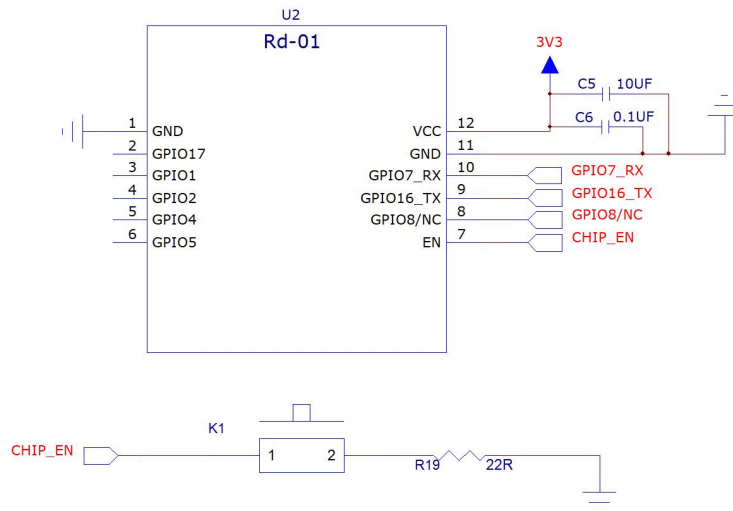

Figure 8 Application guide circuit

Note: The IO port is used as PWM. It is recommended to reserve 4.7K pull-down resistance around the module. In particular, the application of the lamp control side prevents the flash phenomenon at the moment of power-on startup.

6.2. Recommended PCB package size

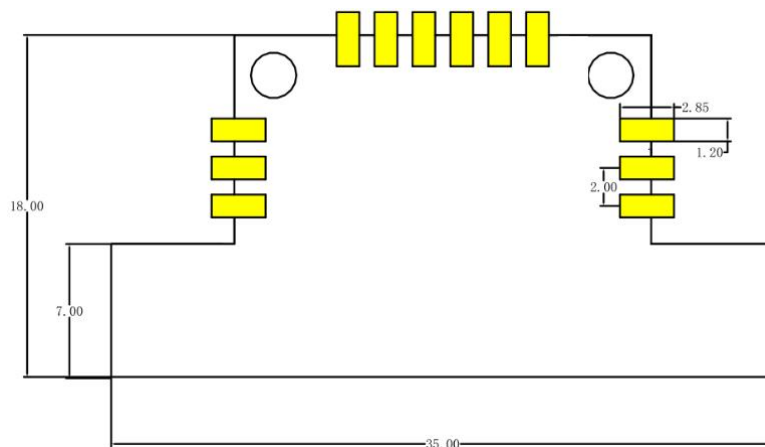

Figure 9 Recommended PCB package size

Note: The Rd-01 module supports a variety of interface modes, including 1.25mm standard 6-pin socket interface, 2.0mm standard pin socket interface, and half-hole SMD patch welding.

- Adopts SMD patch welding method, modules in the radar antenna back has components to avoid empty.

6.3. Precautions for radar installation

- In motherboard installation position, it is recommended that the following several ways:
- ✓ As far as possible to ensure that the radar antenna is opposite to test area, and the antenna around open without sunscreen.
- ✓ ensure that the radar installation position is firm, stable, shaking will influence the effect of detection of radar itself.
- ✓ ensure that there won't be on the back of radar object movement or vibration. Due to the penetrating nature of radar waves, the antenna signal back lobe may detect moving objects on the back of the radar. A metal shield or metal backplane can be used to shield the radar back flap to weaken the influence of objects on the back of the radar.
- ✓ The theoretical range accuracy of radar is obtained by special algorithm on the basis of the physical resolution of 0.75m. As target size, condition, different, such as RCS target distance accuracy will fluctuate; And the farthest distances fluctuate a little bit.
- In order to meet the performance of on-board antenna, antenna surrounding prohibited, metal pieces, far away from the high frequency components.

6.4. Installation environment requirements

This product needs to be installed in a suitable environment. If it is used in the following environments, the detection effect will be affected:

- Induction of continuous movement in the area of nonhuman objects, such as animals, sustained oscillation of the curtain, is the outlet of the large strain of green plant, etc.
- induction area exists the strong reflector of large area, strong reflector is of the radar antenna can cause interference.
- When mounting the wall, need to consider the top of the indoor air conditioning, electric fan etc. External interference factors.

6.5. Installation mode and induction range

■ Hanging roof installation

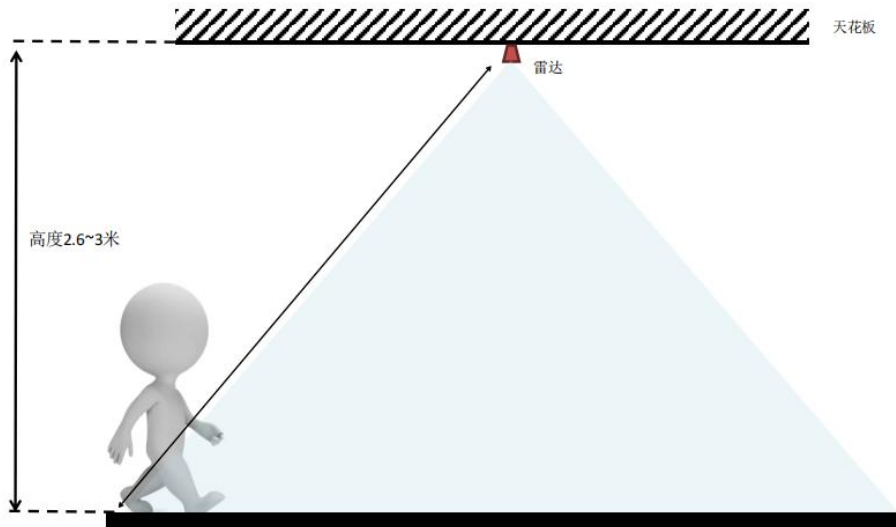

Figure 10 Schematic diagram of mounting the roof

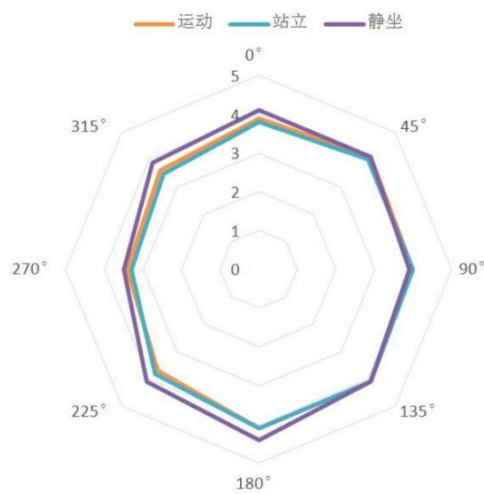
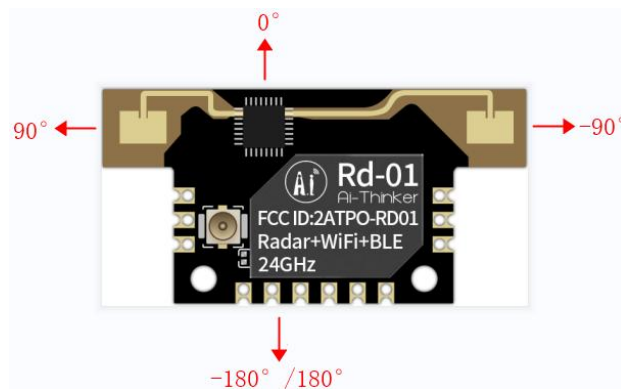

Figure 11 Detection range of mounting roof

■ Wall mounting mode

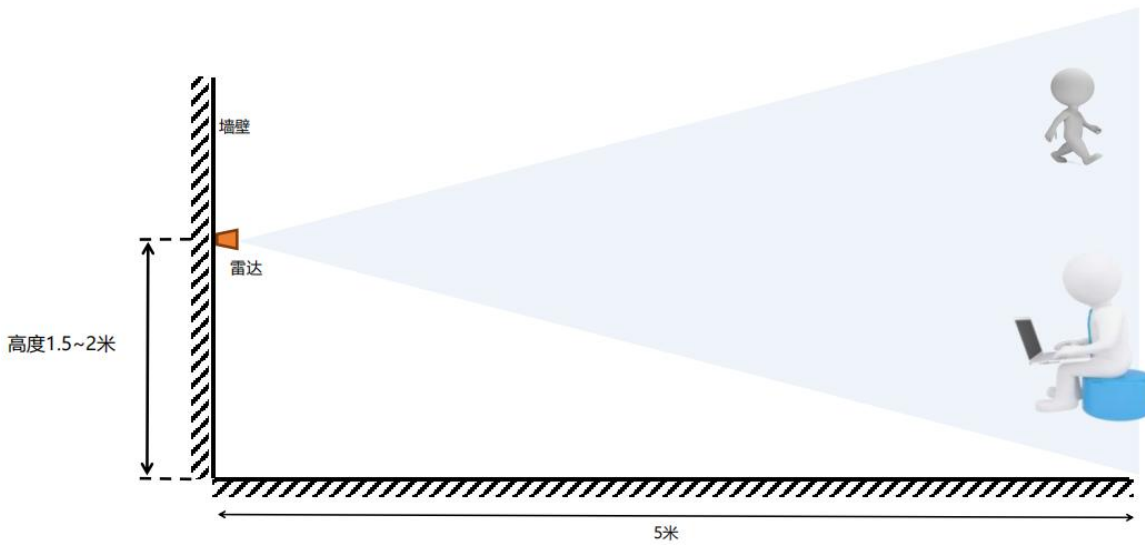

Figure 12 Schematic diagram of wall mounting

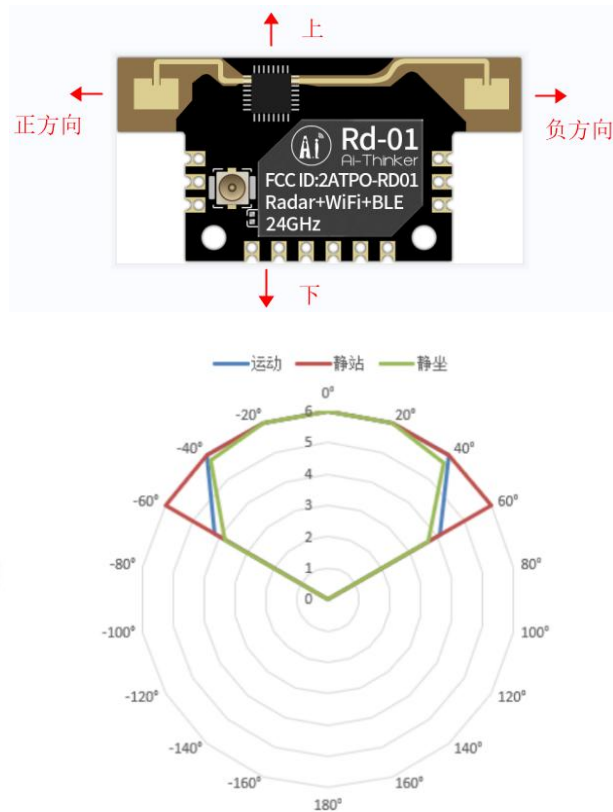

Figure 13 Schematic diagram of detection range of wall mounting

6.6. Power Supply

- Recommended voltage is 3.3V and the peak current is above 500mA.
- Recommended to use LDO as power supply ; If using DC-DC, it is recommended to control ripple within 30mV.
- DC - DC power supply circuit suggested the reserved capacitance position, dynamic response can be large changes in load and optimize the output ripple.
- 3.3V power supply interface increases ESD device is recommended.

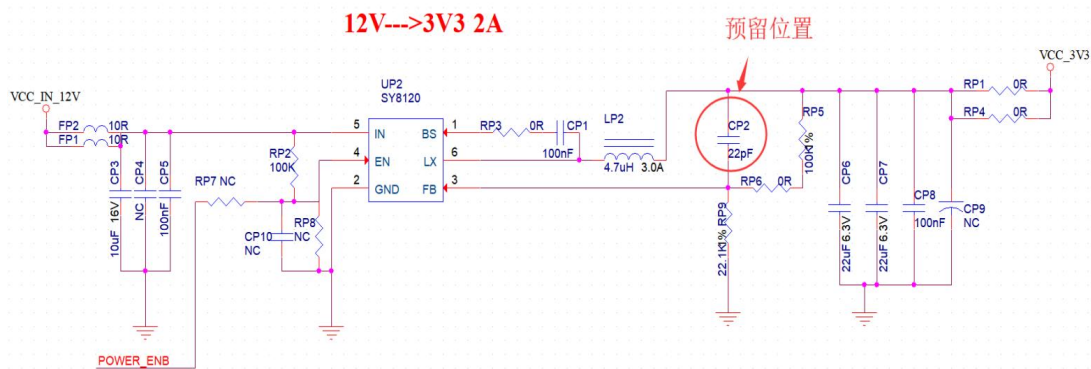

Figure 14 DC-DC step-down circuit diagram

6.7. GPIO

- Some IO ports are drawn from the periphery of the module. If necessary, it is recommended to use 10-100 ohm resistors in series on the IO ports. It can suppress overshoot, so make level both sides more smoothly. It helps EMI and ESD.
- Special IO mouth pull up or down, need to refer to instructions on the use of the specification, here will affect the launch configuration module.
- Module IO port is 3.3 V if the master IO mouth level does not match with module, need to increase the level conversion circuit.
- If IO mouth directly connected to the peripheral interface, or terminal, such as row needles, and Suggestions on the IO mouth line near the terminal obligate ESD device

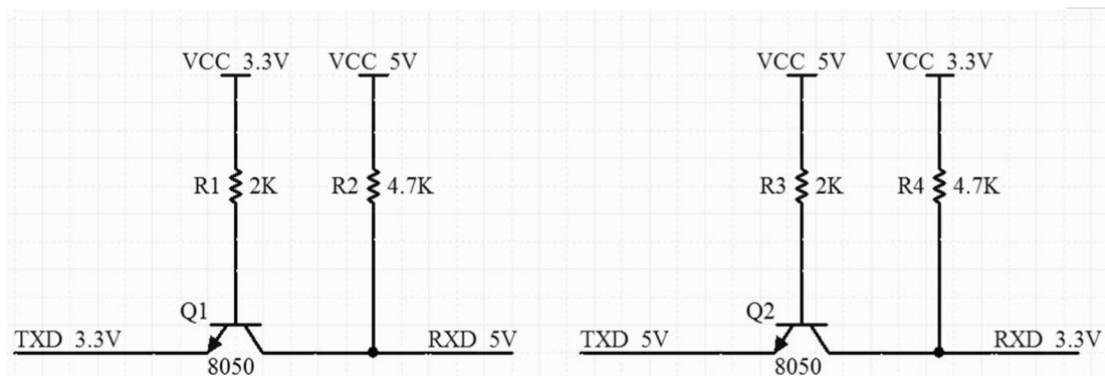

Figure 15 Level switching circuit

7. Storage conditions

Products sealed in moisture-proof bags should be stored in a non-condensing atmosphere at $<40^{\circ}\text{C}/90\%\text{RH}$.

The module's moisture sensitivity level MSL is level 3.

After the vacuum bag is unwrapped, it must be used within 168 hours at $25 \pm 5^{\circ}\text{C}/60\%\text{RH}$.

Otherwise, it needs to be baked before it can be put on line again.

8. Reflow welding curve diagram

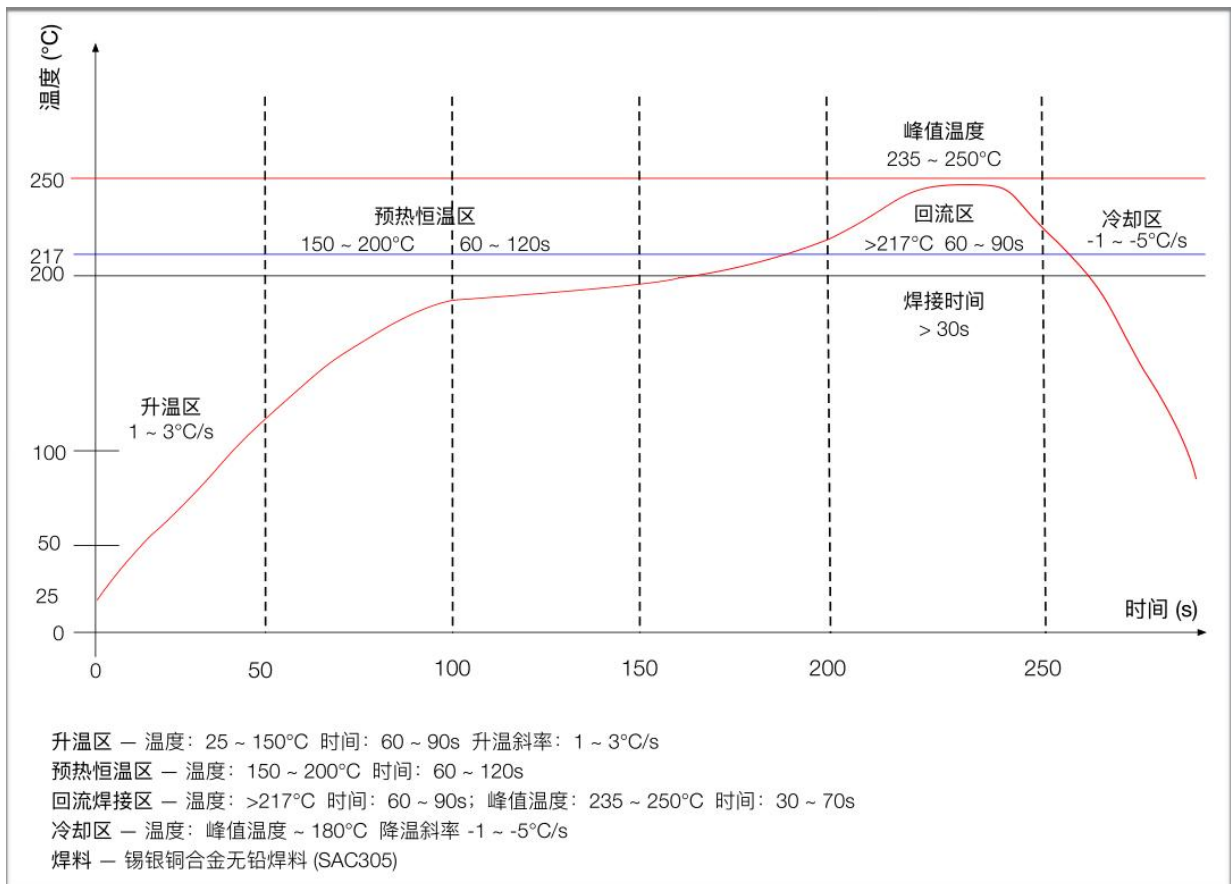

Figure 16 Reflow welding curve

9. Product package information

Rd-01 module (without socket) adopts anti-static braids packing, 800pcs/ tray. As shown in the picture below:



Figure 17 Packing braid

Table 8 Package information table

Packing List	Packaging method	Quantity per tray (tray)
Rd-01 module (with socket)	Anti-static transparent PET tray	25pcs

10. Contact us

[Ai-Thinker official website](#)

[Official Forum](#)

[Develop DOCS](#)

[LinkedIn](#)

[Tmall shop](#)

[Taobao shop](#)

[Alibaba shop](#)

[Technical support Email: support@aithinker.com](mailto:support@aithinker.com)

[Domestic business cooperation: sales@aithinker.com](mailto:sales@aithinker.com)

[Overseas business cooperation: overseas@aithinker.com](mailto:overseas@aithinker.com)

Company address: Room 403,408-410, Block C, Huafeng Smart Innovation Port, Gushu 2nd Road, Xixiang, Baoan District, Shenzhen.

Tel: 0755-29162996



WeChat mini

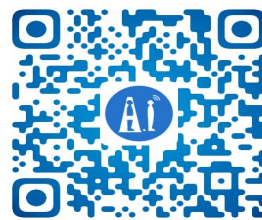

WeChat official

Disclaimer and copyright notice

The information in this article, including the URL address for reference, is subject to change without notice.

The document is provided "as is" without any guarantee responsibility, including any guarantee for merchantability, suitability for a specific purpose, or non-infringement, and any guarantee mentioned elsewhere in any proposal, specification or sample. This document does not bear any responsibility, including the responsibility for infringement of any patent rights arising from the use of the information in this document. This document does not grant any license for the use of intellectual property rights in estoppel or other ways, whether express or implied.

The test data obtained in the article are all obtained from Ai-Thinker's laboratory tests, and the actual results may vary slightly.

All brand names, trademarks and registered trademarks mentioned in this article are the property of their respective owners, and it is hereby declared.

The final interpretation right belongs to Shenzhen Ai-Thinker Technology Co., Ltd.

Notice

Due to product version upgrades or other reasons, the contents of this manual may be changed.

Shenzhen Ai-Thinker Technology Co., Ltd. reserves the right to modify the contents of this manual without any notice or prompt.

This manual is only used as a guide. Shenzhen Ai-Thinker Technology Co., Ltd. makes every effort to provide accurate information in this manual. However, Shenzhen Ai-Thinker Technology Co., Ltd. does not guarantee that the contents of the manual are completely free of errors. All statements and information in this manual. And the suggestion does not constitute any express or implied guarantee.

Statement

Ai-Thinker may provide technical and reliability data (including data sheets), design resources (including reference designs), application or other design recommendations, network tools, safety information and other resources (the "Resources") "as is" without warranties of any kind, express or implied. Including, but not limited to, express or implied warranties of suitability, fitness for a particular use, or non-infringement of any third party's intellectual property rights. And specifically declares that it is not liable for any necessary or incidental losses, including but not limited to, arising from the application or the use of any of our products and circuits.

Ai-Thinker reserves the right to release information in this document (including but not limited to metrics and product descriptions) and any changes to our products without prior notice. This document automatically supersedes and replaces all information provided in previous versions of the same document number file.

These resources are available to skilled developers who design with Ai-Thinker products. You are solely responsible for: (1) Selecting the appropriate Ai-Thinker products for your application; (2) Design, validate, and run your application and product throughout its life cycle; (3) Ensure that your application meets all applicable standards, codes and laws, as well as any other functional security, information security, regulatory or other requirements.

Ai-Thinker may authorize you to use these resources only for the development of applications of Essence Products described in this Resource. Without the permission of Ai-Thinker, any unit or individual shall not extract or copy part or all of these resources, and shall not be transmitted in any form. You are not entitled to use any other Ai-Thinker intellectual property rights or any third party intellectual property rights. You shall indemnify you in full for any claims, damages, costs, losses and liabilities arising against Ai-Thinker or its representatives in connection with the use of these resources, for which Ai-Thinker is not liable.

The products offered by Ai-Thinker are subject to the terms of sale of Ai-Thinker or other applicable terms attached to Essence's products. Essence's availability of these resources does not extend or otherwise change the warranties or warranties disclaimers applicable to product releases.